

DG12864A2

128x64
1/64 Duty, 1/9 Bias

1. External Dimension

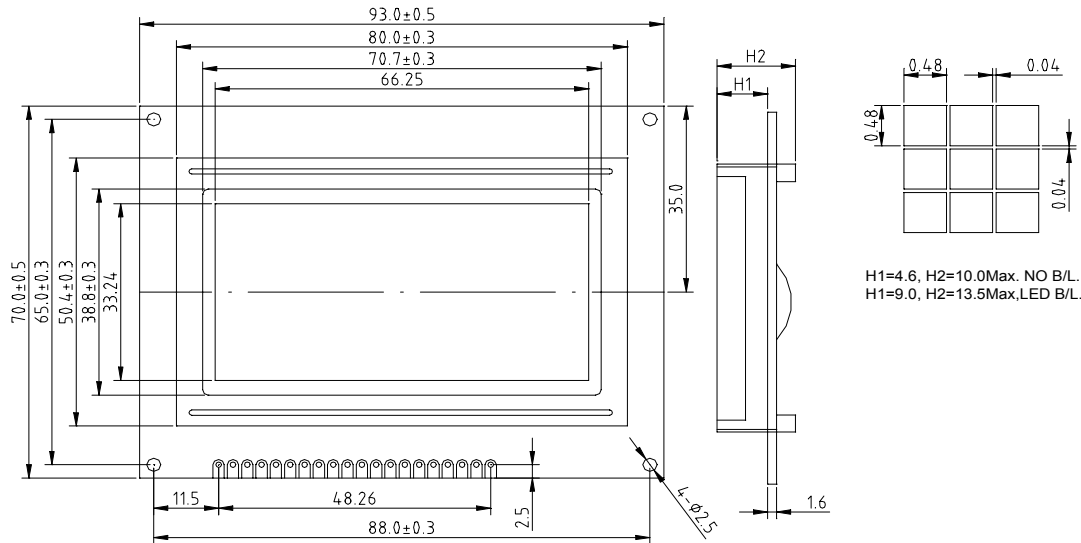

2. Pin Table

1	2	3	4	5	6	7	14	15	16	17	18	19	20
Vss	Vdd	V0	R/S	R/W	E	DB0	DB7	CS1	CS2	RST	Vee	LED+	LED-

3. Block Diagram

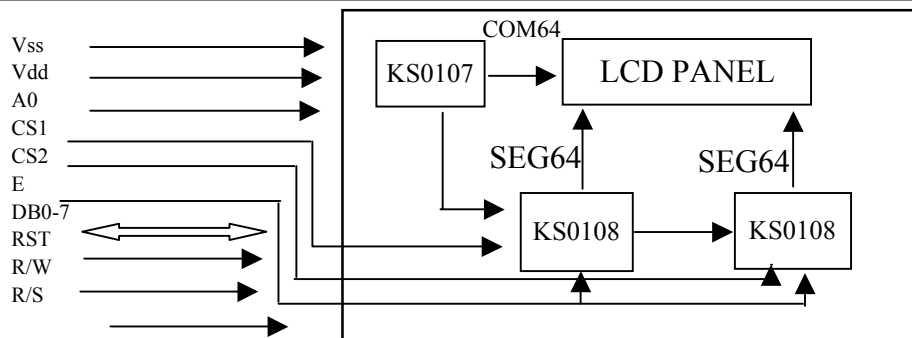

4. Electrical Characteristics (Ta=25°C, Vdd=5.0V±0.25V)

Item	Symbol	Test Condition	Min.	Typ.	Max.	Unit
Input High Voltage	Vih	-	0.7Vdd		Vdd	V
Input Low Voltage	Vil	-	0		0.8	V
Output High Voltage	Voh	-I OH=0.2mA	Vdd-0.4			V
Output Low Voltage	Vol	I ol=1.2mA			0.4	V
Supply Current	Idd	Vdd=5.0V		4		mA
Operating Voltage for LCD	Vdd-V0	STN		12.5		V
		TN		-		V